

06 Series Modular Valves

The modular valves are functional elements with which a hydraulic system can be built easily by stacking them with the mounting bolts. Therefore, no piping is required for the manufacture of the hydraulic systems. Yuken's 06 Series Modular Valves are widely used in hydraulic systems for the various industrial and marine equipment including machine tools, special purpose machines, presses, steel mill equipment and ships. The Valves have standardized mounting surface conforming to ISO 4401-AE-08-4-A and optimum thickness for the stacking.

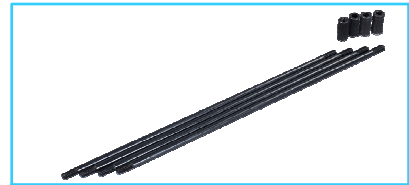

■ Example of Stacking Configuration

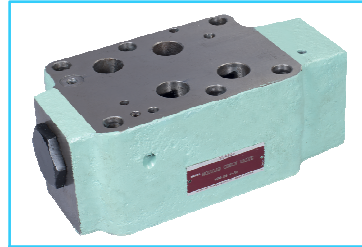
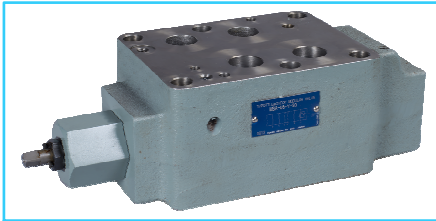
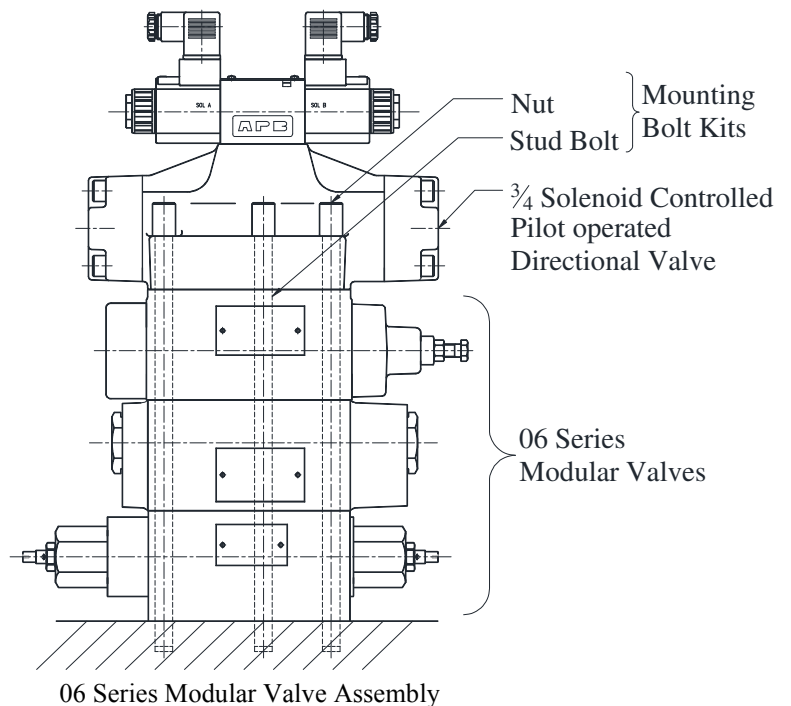
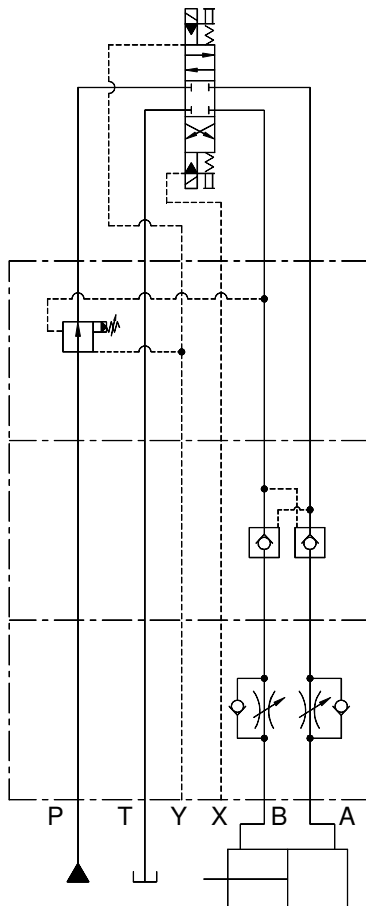

Types of Modular Valve

Class	Model Numbers	Graphic Symbols	Page	Class	Model Numbers	Graphic Symbols	Page	
Pressure Control Valves	Solenoid Controlled Pilot Operated Directional Valve (S-)DSHG-06-XXXX-51		EIC-E-1003	Direction Control Valves	Pilot Operated Check Valves (for "A-Line", Internal Pilot-Internal Drain Type) MPA-06-XX-30H01		528	
	Reducing Valves (for "P-Line") MRP-06-XX-70		522		Pilot Operated Check Valves (for "A-Line", External Pilot-External Drain Type) MPA-06-XX-70		528	
	Reducing Valves (for "A-Line") MRA-06-XX-70		522		Pilot Operated Check Valves (for "A-Line", External Pilot-Internal Drain Type) MPA-06-XX-70		528	
	Reducing Valves (for "B-Line") MRB-06-XX-70		522		Pilot Operated Check Valves (for "B-Line", Internal Pilot-Internal Drain Type) MPB-06-XX-30H01		528	
Flow Control Valves	Throttle and Check Valves (for "A-Line", Metre-out) MSA-06-X-30H01		525		Pilot Operated Check Valves (for "B-Line", External Pilot-External Drain Type) MPB-06-XX-70		538	
	Throttle and Check Valves (for "A-Line", Metre-in) MSA-06-Y-30H01		525		Pilot Operated Check Valves (for "B-Line", External Pilot-Internal Drain Type) MPB-06-XX-70		528	
	Throttle and Check Valves (for "B-Line", Metre-out) MSB-06-X-30H01		525		Pilot Operated Check Valves (for "A&B Lines", Internal Pilot-Internal Drain Type) MPW-06-XX-30H01		528	
	Throttle and Check Valves (for "B-Line", Metre-in) MSB-06-Y-30H01		525		Mounting Bolts	Bolt Kits MBK-06-XX-30/70		532
	Throttle and Check Valves (for "A&B-Line", Metre-out) MSW-06-X-30H01		525					
	Throttle and Check Valves (for "A&B-Line", Metre-in) MSW-06-Y-30H01		525					

- *1 Because drain ports "V" and "W" are not provided for solenoid controlled pilot operated directional valves of Pressure centred Type (3H~~XX~~) and models with Pilot Piston (P~~XX~~), those valves cannot be used in combination with modular valves.
- *2 For the details of solenoid controlled Pilot Operated Directional Valves, see the following catalogue: Catalogue No. Pub. EIC-E-1003.

Instructions

Caution in the selection of valves and circuits designing

The selection of modular valves, to suit a particular functions or hydraulic circuit, are made in exactly the same way as conventional valves, taking into account of the flow and pressure of each valve to be used. In some cases, the stacking system may be restricted. So please refer to the following instructions for stacking sequence. Please note that, when designing a system using modular stacking valves, due consideration should be given to working space for future maintenance.

Stacking sequence when using reducing valves (for "A" or "B" Line) and throttle check valves (for metre-out).

In B to T flow in the drawing left (incorrect), pressure is generated at part with a throttle effect of the throttle and check valve. Depending upon the pressure so generated, the reducing valve may perform a pressure reducing function which causes a shortage of output power of the cylinder and spoils the smooth operation of the cylinder. Therefore, stacking sequence in the drawing right (correct) is required in this combination.

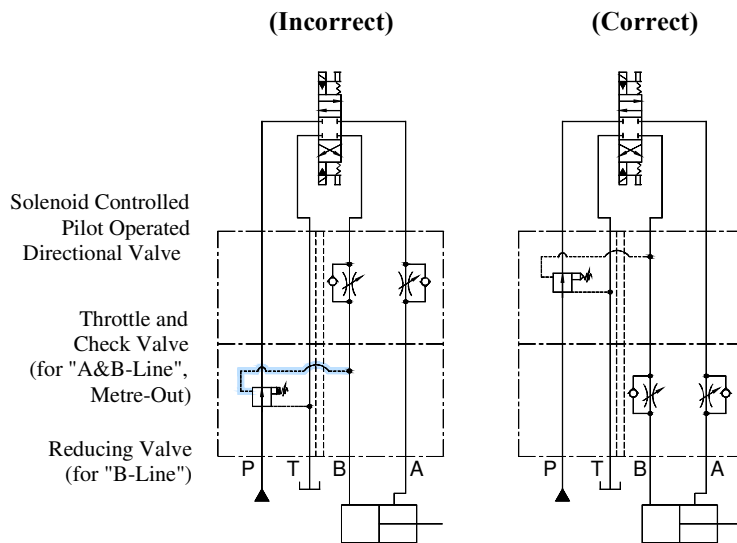

Stacking sequence when using pilot operated check valves and throttle and check valves (metre-out).

In A to T flow in the drawing left (incorrect), Pressure is generated at part with a throttle effect of the throttle and check valve.

The pressure so generated acts to shut the pilot operated check valve and eventually creates an open and shut operation of the valve repeatedly which may causes the cylinder to have a knocking effect (the same effect will occur in case of B to T flow). Therefore, the stacking sequence in the drawing right (correct) is required in this combination.

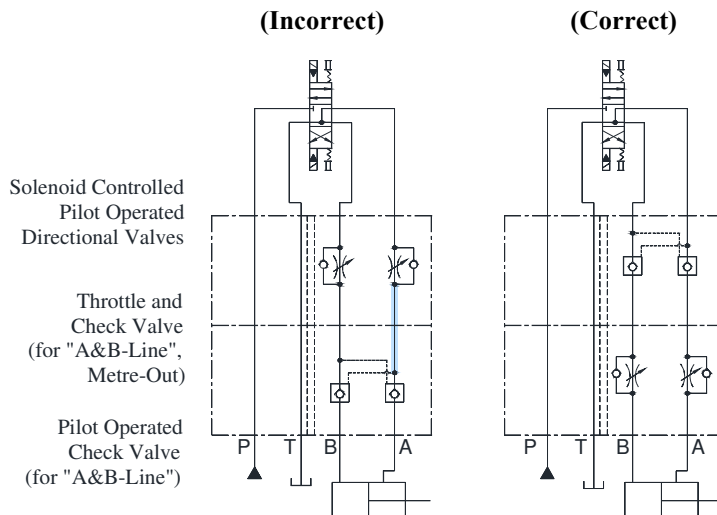

Specifications

- Max. Operating pressure 250Kgf/cm²
- Max. Flow Rate 500 L/min.
- Number of stack 1 to 5 stacks*

* The number of stacks includes the controlled pilot operated Directional valve.

3/4 Solenoid Controlled Pilot Operated Directional Valves

YUKEN 06 SERIES MODULAR VALVES are designed for use with solenoid controlled pilot operated directional valve having an ISO 4401-AE-08-4-A (CETOP-8, NFPA-D06) interface such as YUKEN's DSHG-06. Please refer to the Catalogue No. Pub. EIC-E-1003 for details.

Hydraulic Fluids

Fluid Types

Any type of hydraulic fluids, listed in the table below can be used.

Petroleum base oils	Use fluids equivalent to ISO VG 32 or VG 46.
Synthetic Fluids	Use phosphate ester or polyol ester fluid. When phosphate ester prefix "F-" to the model number because the special seals (fluororubber) are required to be used.
Water containing Fluids	Use water-glycol fluids.

Note: For use with hydraulic fluids other than those listed above, please consult your Yuken representatives in advance.

Recommended Viscosity and Temperature

Always be sure to use hydraulic fluids within the stipulated conditions shown below.
 Viscosity: 15 to 400mm²/s, Temperature: -15⁰ to +70⁰C

Control of contamination

Due caution must be paid to maintaining control over contamination of the hydraulic fluids which may otherwise lead to breakdowns and shorten the life of the valve. Please maintain the degree of contamination within NAS 1638-Grade 12. Use 25µm or finer line filter.

Sub-Plates

When mounting the modular valves, use sub-plates specified below. If these sub-plates are not used, ensure that the mounting surface has a good machined finished.

Sub-Plates Model Numbers: DHGM-06※-50

Note: For the Details of Sub-Plates, See the Catalogue No. EIC-E-1003.

Mounting Bolts

06 Series modular valves are mounted using stud bolts which are supplied in a kit form. When mounting, see the following table for tightening torque. After the test run, be sure to tighten again firmly within the specified torque.

Assembly

Assembly should be carried out in clean conditions and in accordance with the following procedure. Cautious attention should be paid to ensure that the interface of the valves are clean and free from dirt or other foreign materials.

Assembly Procedure

- 1) Screw-in the six stud bolts, fully into the tapped holes on the mounting surface of the specified sub-Plate or manifold.
- 2) Referring to the circuit diagram, stack the modular valve and the solenoid controlled pilot operated directional valve. Take care to face their O-Ring side to the sub-Plate or manifold, put the stud bolts in position and be sure to check that the locating pins are at the pin holes.
- 3) Align both the end of the valves stacked.
- 4) Screw-in the six nuts onto the stud bolts and tighten with the specified torque. After the test run, be sure to re-tighten the nuts firmly within the specified torque.

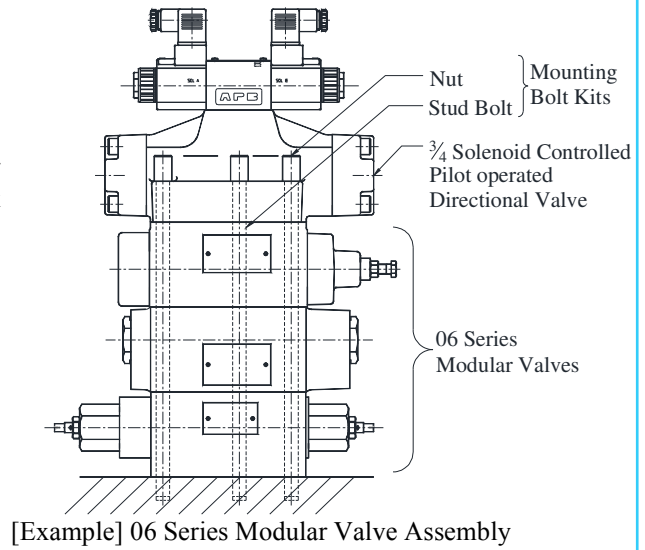

CAUTION

- Keep all installation holes and surfaces clean. Failure to do this may cause fire due to oil leakage.
- Before installing the product, be sure that all specified bolts are tightened to the specified torque levels. Outside specifications may cause improper operation, damage, oil leakage, etc.

Pressure Drop

Pressure drop curves of the modular valves are those based on viscosity of 35 mm²/s and specific gravity of 0.850. When using the modular valves in conditions other than the above mentioned, find the appropriate values referring to the following table and formula.

- For any other viscosity, multiply the factors in the table below.

Viscosity	mm ² /s	15	20	30	40	50	60	70	80	90	100
Factor		0.81	0.87	0.96	1.03	1.09	1.14	1.19	1.23	1.27	1.30

- For any other specific gravity (G'), the pressure drop (ΔP') may be obtained from the following formula.

$$\Delta P' = \Delta P(G' / 0.850)$$

Reducing Modular Valves

Specifications

Model Numbers	Max. Oper. Pressure Kgf/cm ²	Max. Flow* L/min.
MR※-06-A-70	350	125
B		500
MR※-06-C-70 H		

* In the pressure adjustment ranges "A" and "B", maximum flow rates are limited by the pressure setting on the secondary side. Referring to the secondary pressure vs. maximum flow characteristics on the following page, use the valve at the maximum flow rate within a zone highlighted with

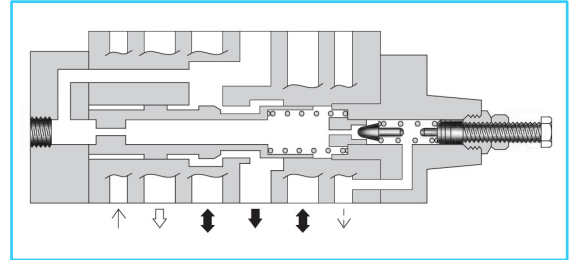
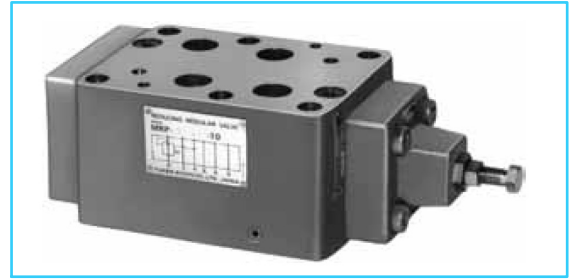

Model Number Designation

F-	MRP	-06	-B	-70
Special Seals	Series Number	Valve size	Pre. Adj. Range Kgf/cm ²	Design Number
F: Special Seals for Phosphate Ester Type Fluids (Omit if not required)	MRP : Reducing valve for P-Line MRA : Reducing valve for A-Line MRB : Reducing valve for B-Line	06	A : 7-70 B : 15-70 C : 35-140 H : 70-250	70

Instructions

- Connect Drain Line (Y Port) to oil tank independently so as to obtain stable pressure setting. At the same time, the solenoid controlled pilot operated directional valve to be used in combination with this valve must be of internal drain type (with T).
- To pressure adjust, loosen the lock nut and turn the pressure adjustment screw clockwise or anti-clockwise. For an increase of pressure, turn the screw clockwise. Be sure to re-tighten the lock nut firmly after making adjustment to the pressure.

Graphic Symbols

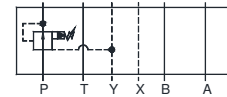

MRP-06

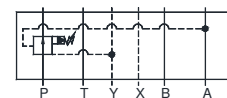

MRA-06

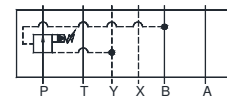

MRB-06

Typical Performance Characteristics

Hydraulic Fluid: Viscosity 35cSt, Specific Gravity 0.850

Pressure Drop

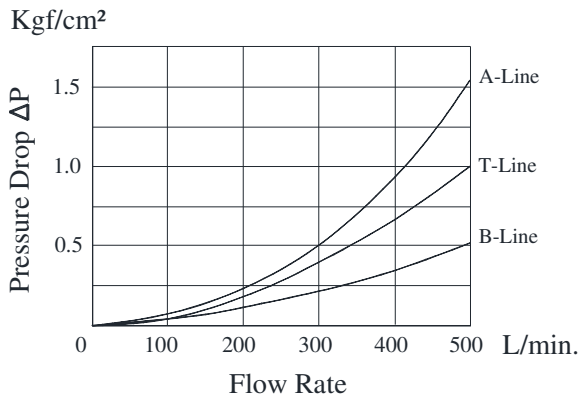

Pressure Drop at Spool Fully Open (P-Line)

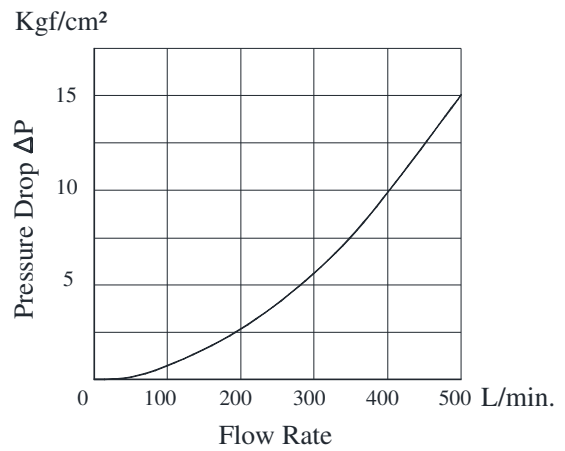

Pilot Flow

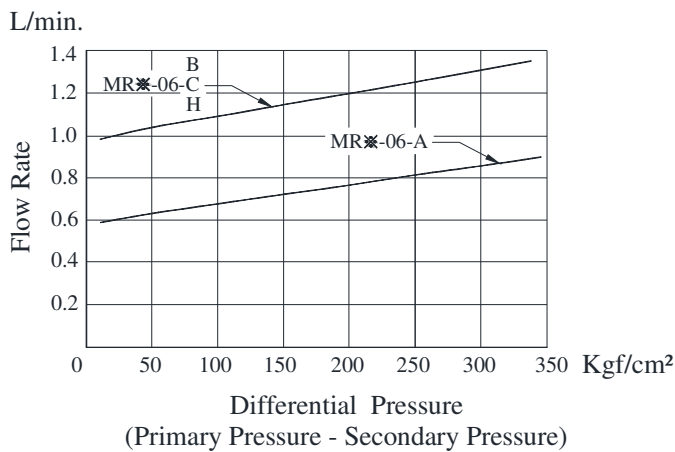

Nominal Override Characteristics

Primary Pressure 350 Kg/cm²

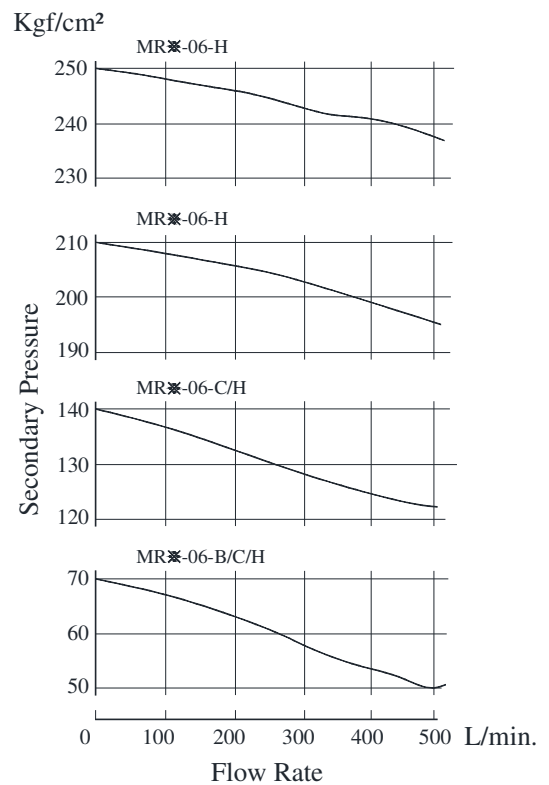

Secondary Pressure Vs. Max. Flow

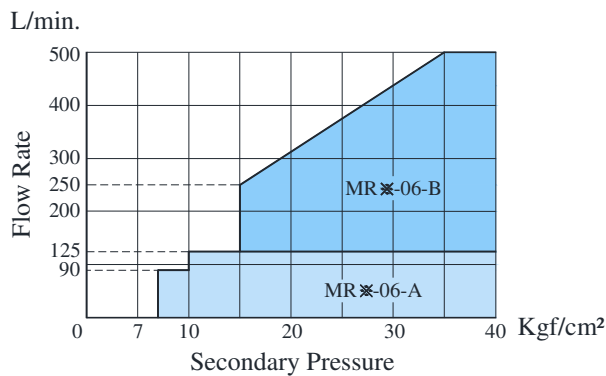

- **MRP-06-※-70**
- **MRA-06-※-70**
- **MRB-06-※-70**

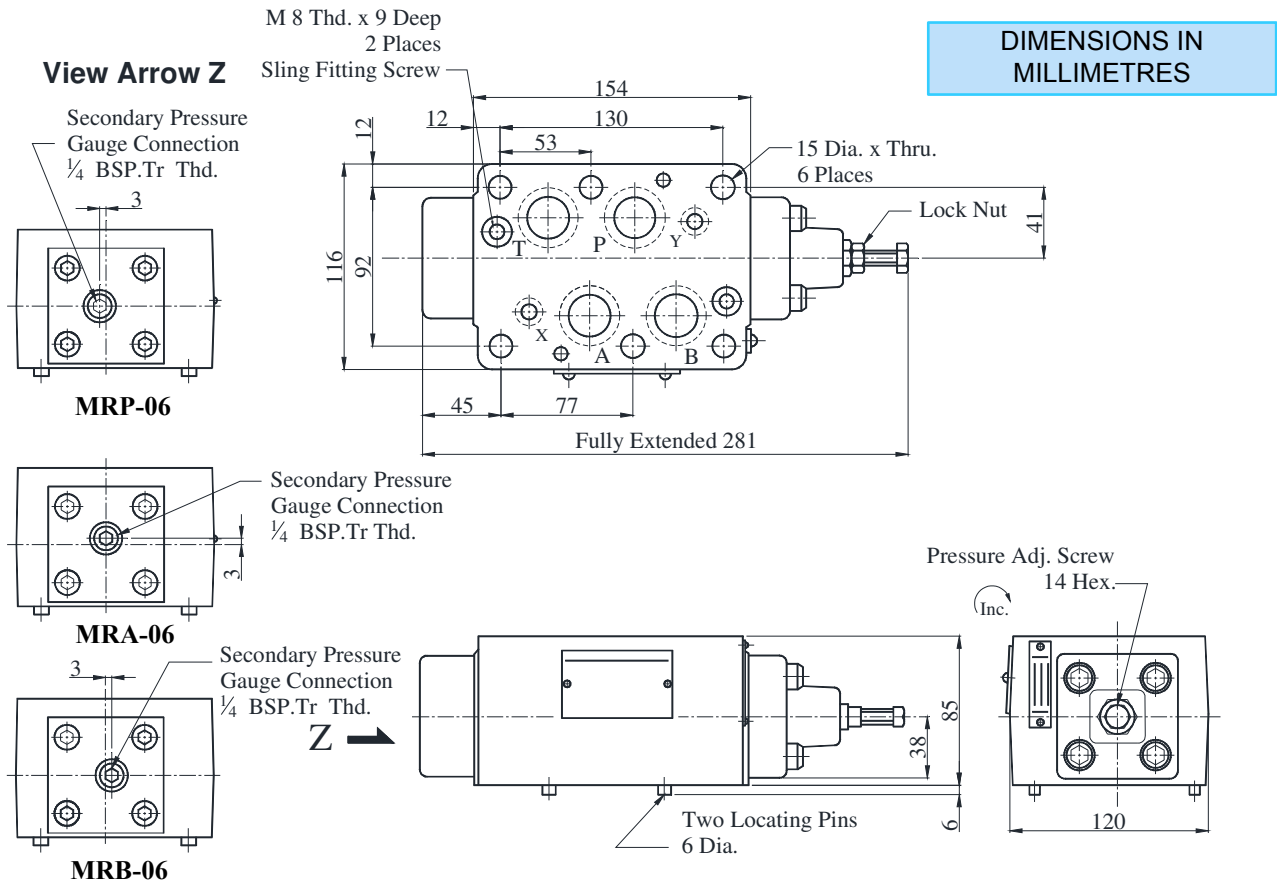

Mass 11.1 Kg (Approx)

■ Spare Parts List

● **List of Seals**

Sl. No.	Name of Parts	Part Nos.	Qty.
1	O-Ring	SO-NA-P9	1
2	O-Ring	SO-NB-P9	5
3	O-Ring	SO-NB-P14	2
4	O-Ring	SO-NB-P28	4
5	O-Ring	SO-NB-P30	2

Note : When ordering the seals, please specify the seal kit KS-MRP-06-70.

■ **3/4 Throttle and check Modular Valves**

■ **Specifications**

Max. Operating Pressure Kgf/cm ²	Max. Flow L/min.
250	500

Graphic Symbols

Model Numbers	Metre-out	Metre-in
MSA-06	 MSA-06-X	 MSA-06-Y
MSB-06	 MSB-06-X	 MSB-06-Y
MSW-06	 MSW-06-X	 MSW-06-Y

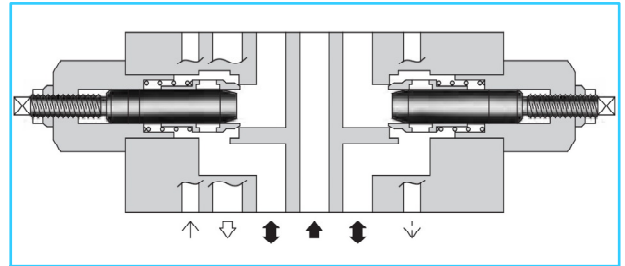

■ **Model Number Designation**

F-	MSA	-06	-X	-30	H01
Special Seals	Series Number	Valve Size	Direction of Flow	Design Number	Design Standard
F: Special Seals for Phosphate Ester Type Fluids (Omit if not required)	MSA: A-Line MSB: B-Line MSW: A & B Line } Throttle and Check Modular Valves	06	X: Metre-Out Y: Metre-In	30	H01

■ **Instructions**

- To **flow adjustment**, loosen the “Lock Nut” then turn the flow adjustment screw clockwise to limit the flow. Be sure to re-tighten the lock nut after the adjustment.

Typical Performance Characteristics

Hydraulic Fluid: Viscosity 35cSt, Specific Gravity 0.850

● **Pressure Drop**

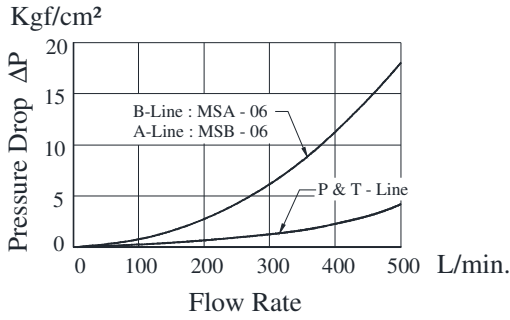

● **Pressure Drop at Throttle Fully Open**

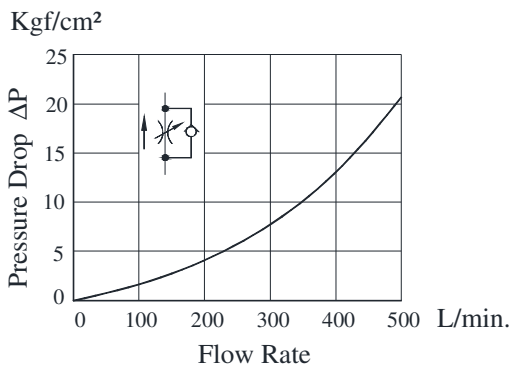

● **Pressure Drop for Free Flow**

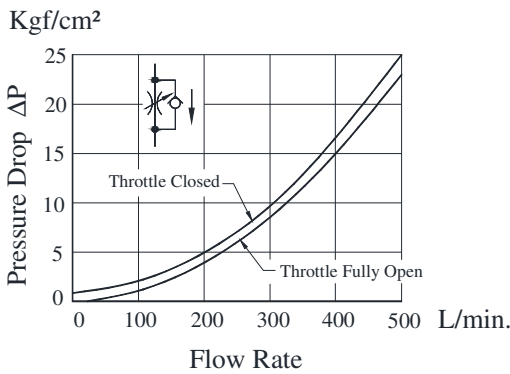

● **Metred Flow vs. Screw Position**

ΔP : Differential Pressure Kg/cm²

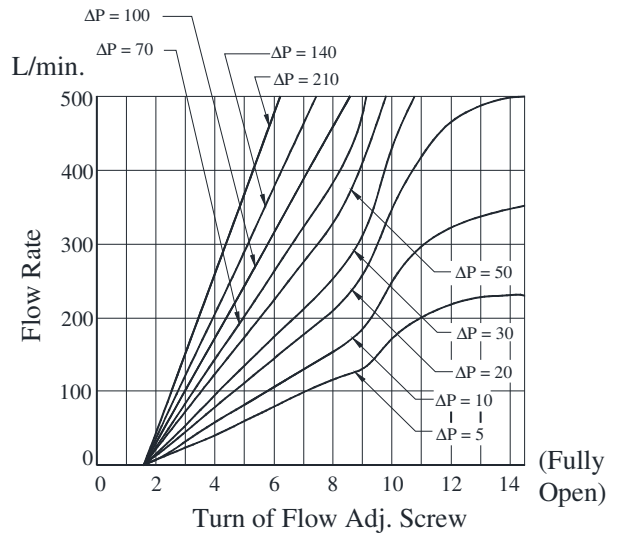

● **MSW-06-X_Y-30H01**

DIMENSIONS IN MILLIMETRES

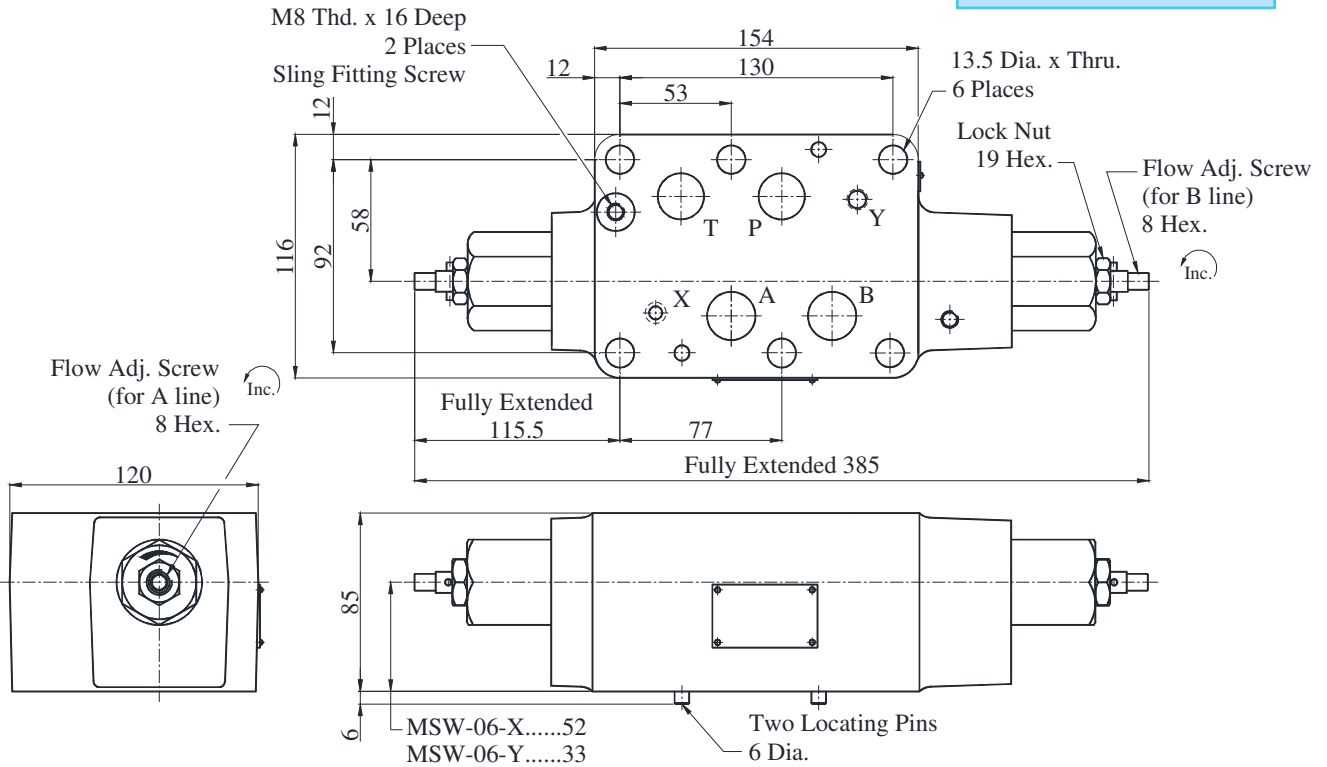

● **MSA-06-X_Y-30H01**

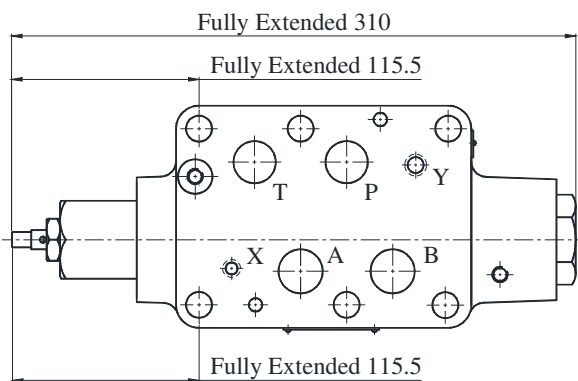

Mass 12Kg(Approx)

For other dimensions, refer to above (MSW-06) drawing.

● **MSB-06-X_Y-30H01**

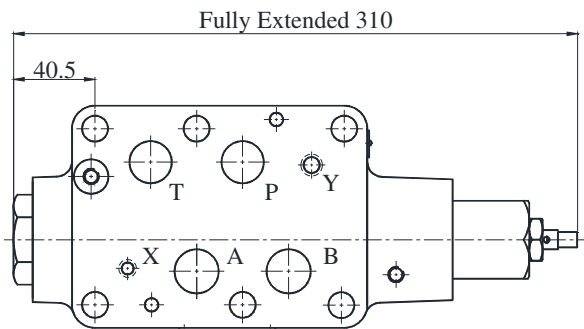

For other dimensions, refer to above (MSW-06) drawing.

Spare Parts List

● **List of Seals**

Sl. No.	Name of Parts	Part Nos.	Quantity		
			MSA-06	MSB-06	MSW-06
1	O-Ring	SO-NA-P14	1	1	2
2	O-Ring	SO-NB-P14	2	2	2
3	O-Ring	SO-NB-P28	4	4	4
4	O-Ring	SO-NB-P32	1	1	2
5	Backup Ring	SO-BB-P14	1	1	2

Note : When ordering the seals, please specify the seal kit numbers from the table below.

● **List of Seal Kits**







Model Nos.	Seal Kit Numbers
MSA-06	KS-MSA-06-30
MSB-06	
MSW-06	KS-MSW-06-30

■ Pilot Operated Check Modular Valves

■ Specifications

Model Numbers	Max. Operating Pressure Kgf/cm ²	Max. Flow L/Min.
MPA-06※-※-※-30H01/70	250	500
MPB-06※-※-※-30H01/70	{For 70 Design	
MPW-06※-※-※-30H01/70	350}	

Graphic Symbols

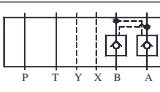
Pilot-Drain Type Model No.	Internal Pilot- Internal drain type	External Pilot- External drain type	External Pilot- Internal drain type
MPA-06	 MPA-06-※	 MPA-06※-※-X	 MPA-06※-※-Y
MPB-06	 MPB-06-※	 MPB-06※-※-X	 MPB-06※-※-Y
MPW-06	 MPW-06-※		

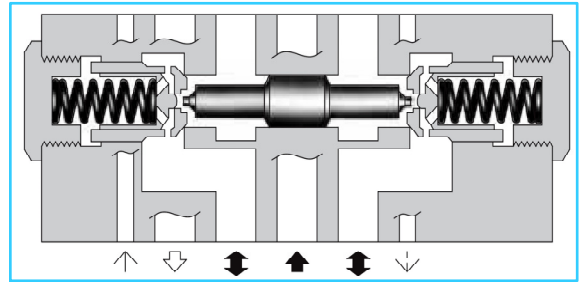
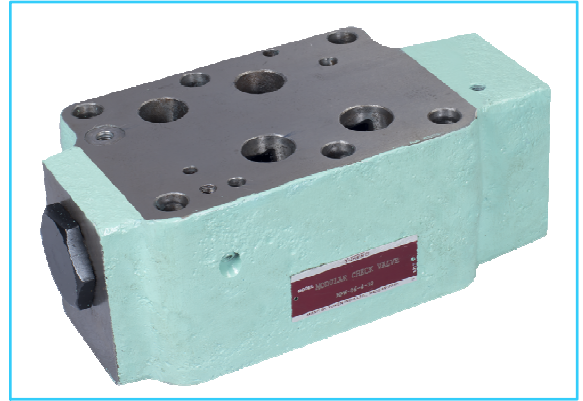

■ Model Number Designation

F-	MPA	-06	S	-2	-X	-30	H01
Special Seals	Series Number	Valve Size	Port Tapping Feature of Pilot-Drain Port *1	Cracking Pressure Kgf/cm ²	Pilot-Drain *2 Connection	Design Number	Design Standard
F: Special Seal For Phosphate Ester Type Fluids (Omit if not required)	MPA: Pilot Operated Check for A-Line	06	None : Taper Thread S: Straight Thread (Applicable only for Japanese std. "JIS")	2 : 2 4 : 4	None: Internal Pilot-Internal Drain	30	H01
	MPB: Pilot Operated Check for B-Line				X : External Pilot-External Drain	70	-
	MPW: Pilot Operated Check for A-B-line				Y : External Pilot-Internal Drain		

*1 This item applies only to External Pilot or External Drain Type.

*2 For MPW valves, 'X' & 'Y' options are not applicable.

● **MP※-06-※-30H01**

■ **Typical Performance Characteristics**

Hydraulic Fluid: Viscosity 35cSt, Specific Gravity 0.850

● **Pressure Drop**

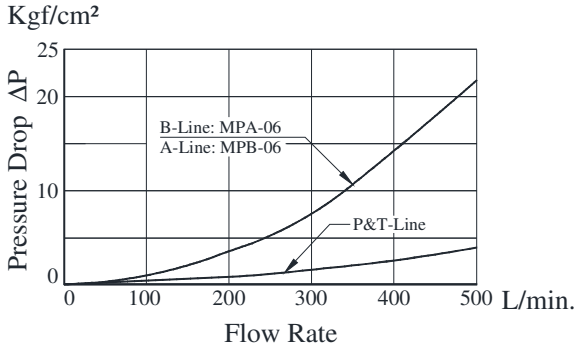

● **Pressure Drop for Reversed Controlled Flow**

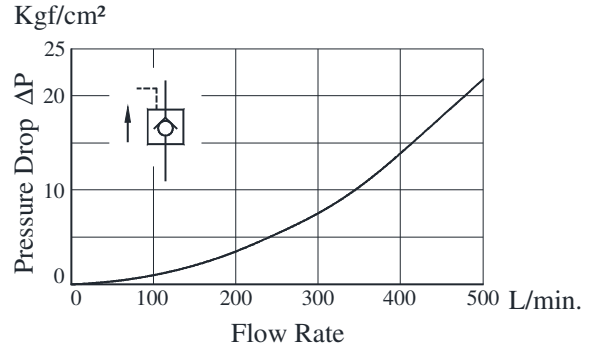

● **Pressure Drop for Free Flow**

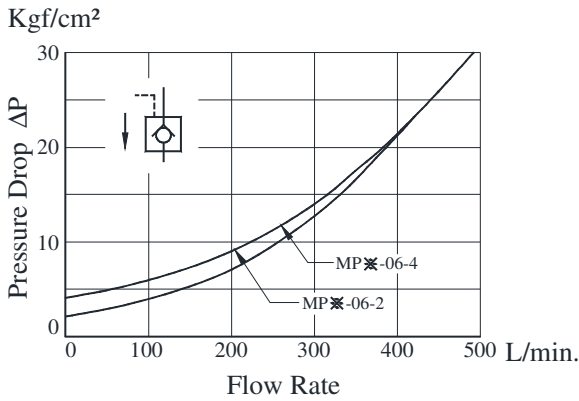

● **Min. Pilot Pressure**

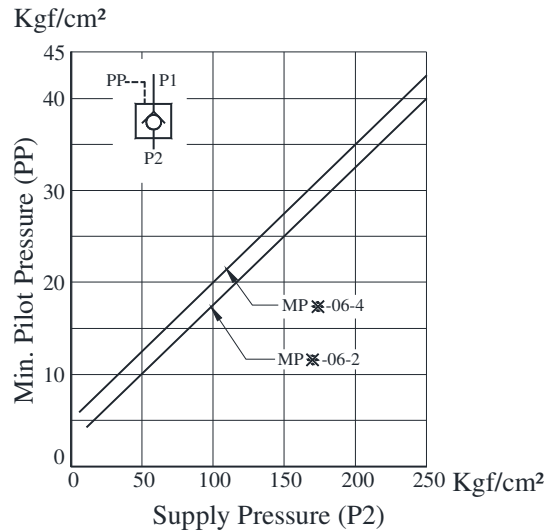

● **MP※-06-※-70**

■ **Typical Performance Characteristics**

Hydraulic Fluid: Viscosity 35cSt, Specific Gravity 0.850

● **Pressure Drop**

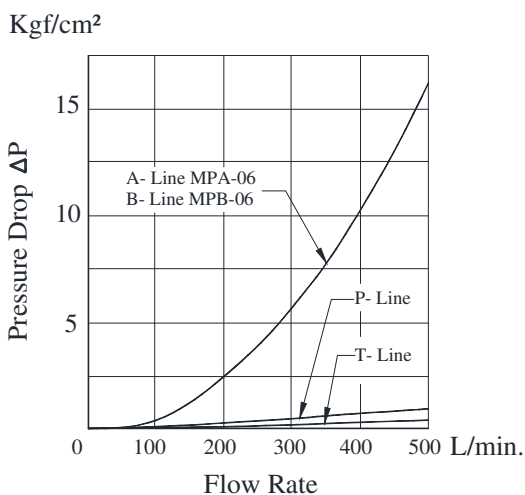

● **Pressure Drop for Reversed Controlled Flow**

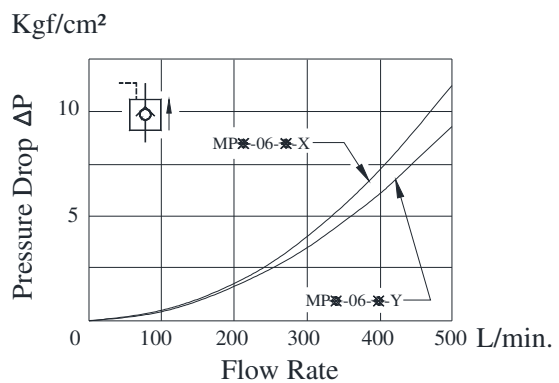

● **Pressure Drop for Free Flow**

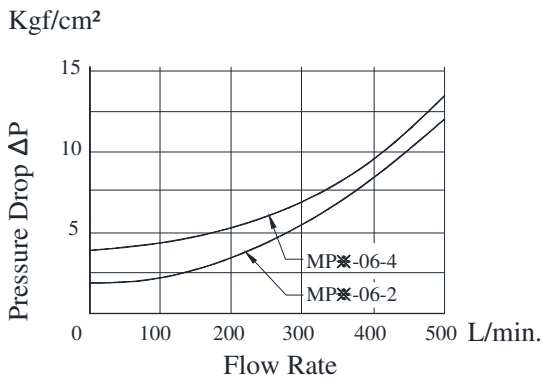

● **Min. Pilot Pressure**

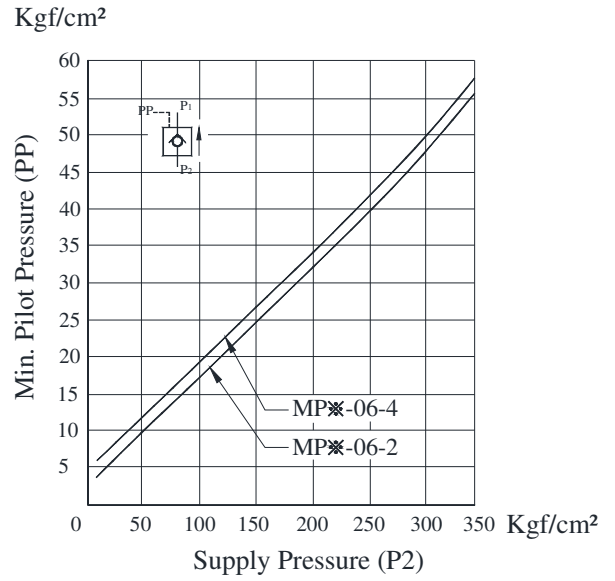

- **MPA-06-※-30H01**
- **MPB-06-※-30H01** (Internal Pilot-Internal Drain Type)
- **MPW-06-※-30H01**

DIMENSIONS IN MILLIMETRES

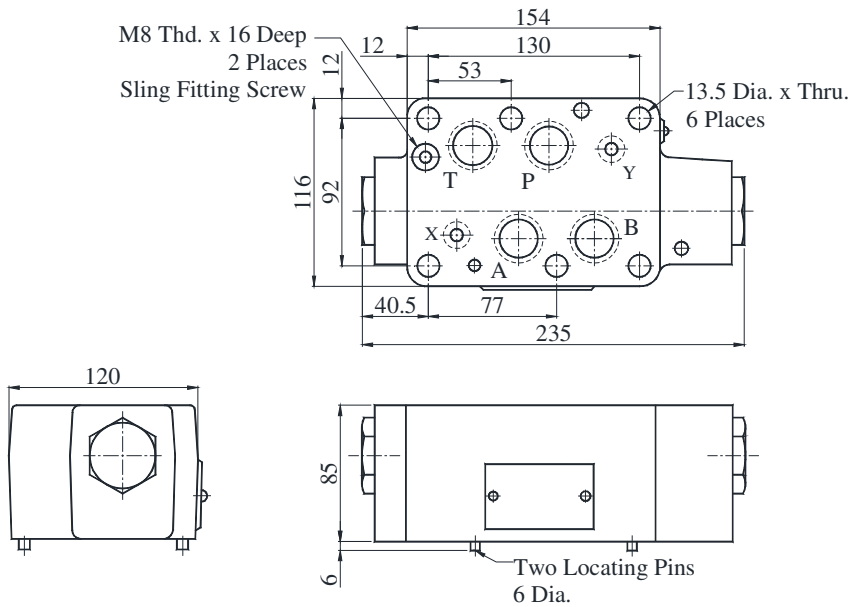

Approx. Mass..... 11.6 Kg.

● **MPA-06-※-※-X-70 (External Pilot-External Drain Type)**

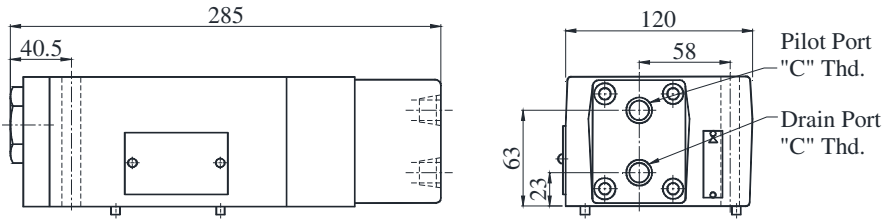

DIMENSIONS IN MILLIMETRES

Approx. Mass..... 13 Kg.

● **MPA-06-※-※-Y-70 (External Pilot-Internal Drain Type)**

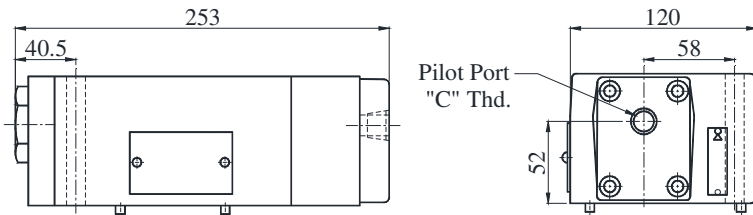

Model Numbers	Thread Size "C" Thd.
MPA-06-※-※-70	Rc 1/4 = 1/4 BSP.Tr.
MPA-06S-※-※-70	G 1/4

Approx. Mass..... 11.6 Kg.

● For other dimensions, refer to "Internal Pilot-Internal drain type" drawing above.

● **MPB-06-※-※-X-70 (External Pilot-External Drain Type)**

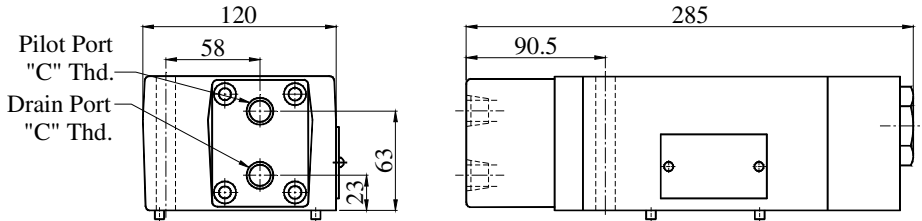

Approx. Mass..... 13 Kg.

● **MPB-06-※-※-Y-70 (External Pilot-Internal Drain Type)**

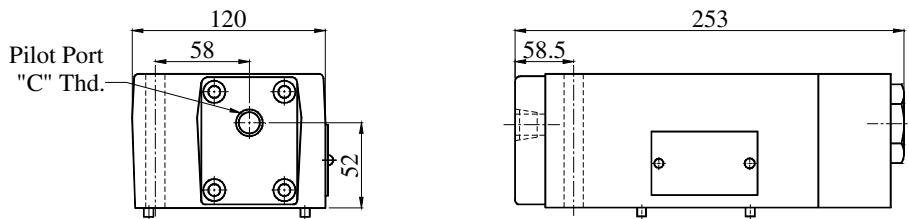

DIMENSIONS IN MILLIMETRES

Approx. Mass..... 11.6 Kg.

● For other dimensions, refer to "Internal Pilot-Internal drain type" drawing above.

Model Numbers	Thread Size "C" Thd.
MPB-06-※-※-70	Rc 1/4 = 1/4 BSP.Tr.
MPB-06S-※-※-70	G 1/4

Spare Parts List

● **List of Seals**

Sl. No.	Name of Parts	Part Nos.	Quantity		
			Internal Pilot-Internal Drain	External Pilot-External Drain	External Pilot-Internal Drain
1	O-Ring	SO-NB-P14	2	2	2
2	O-Ring	SO-NA-P26	-	1	-
3	O-Ring	SO-NB-P28	4	4	4
4	O-Ring	SO-NB-P32	2	1	1
5	O-Ring	SO-NB-P36	-	1	1

Note : When ordering the seals, please specify the seal kit numbers from the table below.

● **List of Seal Kits**

Model Nos.	Seal Kit Numbers
MPA-06-※	KS-MPA-06-30
MPB-06-※	
MPW-06-※	
MPA-06※-※-X	KS-MPA-06-X-70
MPB-06※-※-X	
MPA-06※-※-Y	KS-MPA-06-Y-70
MPA-06※-※-Y	

■ Mounting Bolt Kits for 3/4 Modular Valves

Valves are mounted with six stud bolts. Valve combination varies according to the circuit type. Hence, the mounting bolt kits are available on a combination type basis. When ordering the mounting bolt kit, be sure to give the bolt kit model number from the table below.

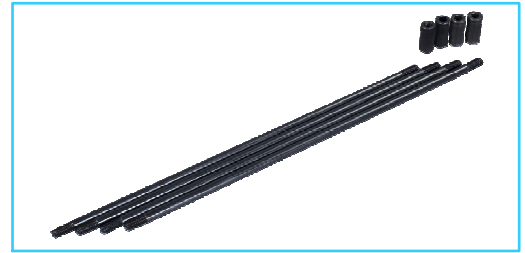

■ Model Number Designation

MBK	-06	-04	-30
Series Number	Size of Modular Valve	Bolt Number	Design Number
MBK : Mounting Bolt kits for Modular Valves	06	01,02,03,04	30
			70

■ Bolt Kits Selection Chart

Bolt Kit Model Numbers	Quantity of Valves to be Stacked		Approx. Mass Kg.	
	Sol. Cont. Pilot Operated Directional Valves (DSHG-06)	Modular Valve	30D	70D
MBK-06-01-※	1	1	1.1	1.2
MBK-06-02-※	1	2	1.5	1.7
MBK-06-03-※	1	3	2.0	2.1
MBK-06-04-※	1	4	2.4	2.6

● Bolt Kit Composition

- Stud Bolt 6 Pcs. } 1 Set
- Nut 6 Pcs. }

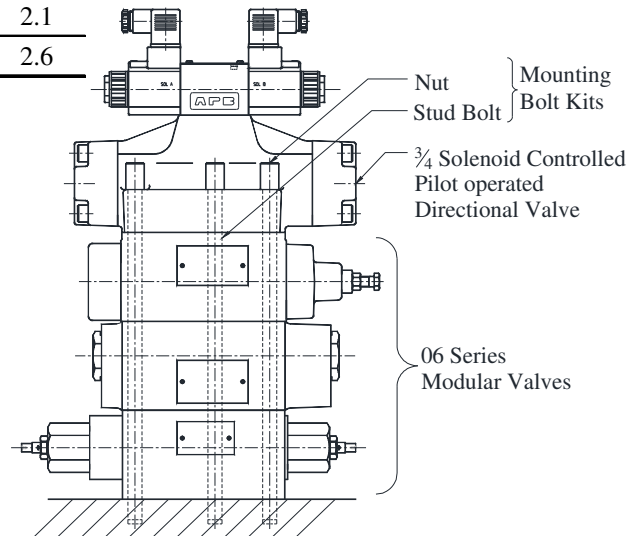

[Example] 06 Series Modular Valve Assembly

● MBK-06-※-※

● Stud Bolt

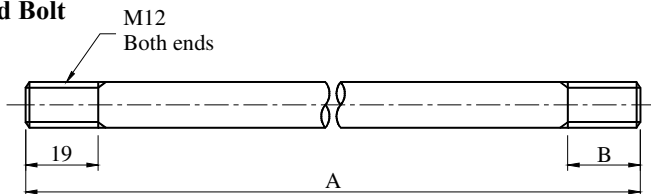

● Nut

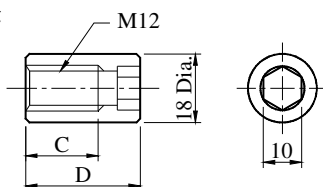

DIMENSIONS IN MILLIMETRES

Model Numbers	30 Design				70 Design			
	A	B	C	D	A	B	C	D
MBK-06-01	161	19	20	30	168	26	27	37
MBK-06-02	246				253			
MBK-06-03	331				338			
MBK-06-04	416				423			

06 Series Modular Valves

Mounting Surface Dimensions For 3/4 Modular Valves

When mounting 06 series modular valve, be sure to use a sub-plate for 3/4 solenoid controlled pilot operated directional valves.

Name	Sub-plate Model Number	Catalogue No.
Sub-plate for 3/4 solenoid Controlled pilot Operated Directional Valves	DHGM-06※-50	EIC-E-1003

Also, When no sub-plates are used, be sure to use the following mounting surface.

